

# Nikon

DIGITAL CAMERA

## COOLPIX P950

### Quick Start Guide

Introduction	ii
Parts of the camera	1
Getting started	2
Basic operations of shooting and playback	8
Other functions	16
If there is a problem	22
Technical notes	23

En

- Read this manual thoroughly before using the camera.
- To ensure proper use of the camera, be sure to read "For your safety" (page vii).
- Be sure to read "Do not point the lens at the sun" (page 26) in "Caring for the product."
- After reading this manual, keep it in a readily accessible place for future reference.

# Introduction

## Types of manuals

### Quick Start Guide (this manual)

Explains preparation for shooting and basic operations.



### Online Manual (HTML) (English)

For detailed explanations, see the English Online Manual. You can view it on a computer or smart device.

The following descriptions are included in the manual.

- Detailed explanations of shooting features, playback features, and menu items
- Connecting to a TV or computer
- Compatible accessories
- Solutions for when you have problems or when error messages are displayed

<https://onlinemanual.nikonimglib.com/p950/en/>



nikon online manual P950



### Reference Manual (PDF) (English)

You can download the content of the Online Manual in PDF format from our Download Center. See the English Reference Manual.

The Reference Manual can be viewed using Adobe Acrobat Reader (downloadable from the Adobe website).

### SnapBridge Online Help

Explains details about using the SnapBridge app.

<https://nikonimglib.com/snbr/onlinehelp/en/index.html>

snapbridge help



COOLPIX P950 Model Name: N1834

## To view images on a computer or smart device

Use the software or app below.

### Software for computers

You can download software from our Download Center.

- ViewNX-i: This software enables you to transfer images and movies to your computer for viewing and editing.
- Capture NX-D: This software enables you to adjust images transferred to your computer and process RAW images.

### App for smart devices

- SnapBridge: When you establish a wireless connection, this app enables you to upload images and movies to your smart device (📖20).

## Visit our Download Center

Visit our website to download manuals for Nikon imaging products, computer software, or firmware.

<https://downloadcenter.nikonimglib.com>

nikon download center P950



## Nikon user support

Visit the site below to register your camera and keep up-to-date with the latest product information. You will find answers to frequently asked questions (FAQs) and can contact us for technical assistance.

<https://www.europe-nikon.com/support>

## Confirming the package contents

In the event that any items are missing, please contact the store where you purchased the camera.



COOLPIX P950 Digital Camera



Strap



LC-67 Lens Cap



EN-EL20a Rechargeable Li-ion Battery



EH-73P Charging AC Adapter\*

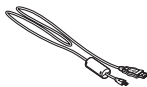

UC-E21 USB Cable



HN-CP20 Lens Hood

Quick Start Guide (this manual)

Warranty (printed on the back cover of this manual)

\* A plug adapter is attached depending on the country or region of purchase. The shape of the plug adapter varies with the country or region of purchase (📖4).

**NOTE:** A memory card is not included with the camera. SD, SDHC, and SDXC memory cards are referred to as "memory cards" in this manual.

# Information and precautions

## Life-long learning

As part of Nikon's "Life-long learning" commitment to ongoing product support and education, continually updated information is available online at the following websites:

- For users in the U.S.A.: <https://www.nikonusa.com/>
- For users in Europe: <https://www.europe-nikon.com/support/>
- For users in Asia, Oceania, the Middle East, and Africa: <http://www.nikon-asia.com/>

Visit these websites to keep up-to-date with the latest product information, tips, answers to frequently asked questions (FAQs), and general advice on digital imaging and photography. Additional information may be available from the Nikon representative in your area. Visit the website below for contact information.

<https://imaging.nikon.com/>

## Before taking important pictures

Before taking pictures on important occasions (such as at weddings or before taking the camera on a trip), take a test shot to ensure that the camera is functioning normally. Nikon will not be held liable for damages or lost profits that may result from product malfunction.

## Use only Nikon brand electronic accessories

Nikon COOLPIX cameras are designed to the highest standards and include complex electronic circuitry. Only Nikon brand electronic accessories (including battery chargers, batteries, AC adapters, and USB cables) certified by Nikon specifically for use with this Nikon digital camera are engineered and proven to operate within the operational and safety requirements of this electronic circuitry.

THE USE OF NON-NIKON ELECTRONIC ACCESSORIES COULD DAMAGE THE CAMERA AND MAY VOID YOUR NIKON WARRANTY.

A holographic seal that indicates an accessory as an authentic Nikon product is affixed to the dedicated rechargeable Li-ion battery.



The use of third-party rechargeable Li-ion batteries not bearing the Nikon holographic seal could interfere with normal operation of the camera or result in the batteries overheating, igniting, rupturing, or leaking.

For more information about Nikon brand accessories, contact a local authorized Nikon dealer.

## About the manuals

- No part of the manuals included with this product may be reproduced, transmitted, transcribed, stored in a retrieval system, or translated into any language in any form, by any means, without Nikon's prior written permission.
- Illustrations and screen content shown in this manual may differ from the actual product.
- Nikon reserves the right to change the specifications of the hardware and software described in these manuals at any time and without prior notice.
- Nikon will not be held liable for any damages resulting from the use of this product.
- While every effort was made to ensure that the information in these manuals is accurate and complete, we would appreciate it were you to bring any errors or omissions to the attention of the Nikon representative in your area (address provided separately).

## Comply with copyright notices

Under copyright law, photographs or recordings of copyrighted works made with the camera can not be used without the permission of the copyright holder. Exceptions apply to personal use, but note that even personal use may be restricted in the case of photographs or recordings of exhibits or live performances.

## Disposing of data storage devices

Please note that deleting images or formatting data storage devices such as memory cards does not completely erase the original image data. Deleted files can sometimes be recovered from discarded storage devices using commercially available software, potentially resulting in the malicious use of personal image data. Ensuring the privacy of such data is the user's responsibility.

Before discarding a data storage device or transferring ownership to another person, make sure to reset all of the camera's settings in the setup menu (📖18) → **[Reset all]**. After resetting, erase all data in the device using commercial deletion software, or format the device in the setup menu (📖18) → **[Format card]**, then completely refill it with images containing no private information (for example, images of empty sky).

Care should be taken to avoid injury or damage to property when physically destroying memory cards.

## For your safety

To prevent damage to property or injury to yourself or to others, read "For your safety" in its entirety before using this product.

Keep these safety instructions where all those who use this product will read them.



### DANGER

Failure to observe the precautions marked with this icon carries a high risk of death or severe injury.



### WARNING

Failure to observe the precautions marked with this icon could result in death or severe injury.



### CAUTION

Failure to observe the precautions marked with this icon could result in injury or property damage.



## WARNING

- **Do not use while walking or operating a vehicle.** Failure to observe this precaution could result in accidents or other injury.
- **Do not disassemble or modify this product. Do not touch internal parts that become exposed as the result of a fall or other accident.** Failure to observe these precautions could result in electric shock or other injury.
- **Should you notice any abnormalities such as the product producing smoke, heat, or unusual odors, immediately disconnect the battery or power source.** Continued operation could result in fire, burns or other injury.
- **Keep dry. Do not handle with wet hands. Do not handle the plug with wet hands.** Failure to observe these precautions could result in fire or electric shock.
- **Do not let your skin remain in prolonged contact with this product while it is on or plugged in.** Failure to observe this precaution could result in low-temperature burns.
- **Do not use this product in the presence of flammable dust or gas such as propane, gasoline or aerosols.** Failure to observe this precaution could result in explosion or fire.
- **Do not aim the flash at the operator of a motor vehicle.** Failure to observe this precaution could result in accidents.

- **Keep this product out of reach of children.** Failure to observe this precaution could result in injury or product malfunction. In addition, note that small parts constitute a choking hazard. Should a child swallow any part of this product, seek immediate medical attention.

- **Do not entangle, wrap or twist the straps around your neck.** Failure to observe this precaution could result in accidents.

- **Do not use batteries, chargers, AC adapters, or USB cables not specifically designated for use with this product. When using batteries, chargers, AC adapters, and USB cables designated for use with this product, do not:**
  - **Damage, modify, forcibly tug or bend the cords or cables, place them under heavy objects, or expose them to heat or flame.**
  - **Use travel converters or adapters designed to convert from one voltage to another or with DC-to-AC inverters.**

Failure to observe these precautions could result in fire or electric shock.

- **Do not handle the plug when charging the product or using the AC adapter during thunderstorms.** Failure to observe this precaution could result in electric shock.
- **Do not handle with bare hands in locations exposed to extremely high or low temperatures.** Failure to observe this precaution could result in burns or frostbite.



## CAUTION

- **Do not leave the lens pointed at the sun or other strong light sources.** Light focused by the lens could cause fire or damage to product's internal parts. When shooting backlit subjects, keep the sun well out of the frame. Sunlight focused into the camera when the sun is close to the frame could cause fire.
- **Turn this product off when its use is prohibited. Disable wireless features when the use of wireless equipment is prohibited.** The radio-frequency emissions produced by this product could interfere with equipment onboard aircraft or in hospitals or other medical facilities.
- **Remove the battery and disconnect the AC adapter if this product will not be used for an extended period.** Failure to observe this precaution could result in fire or product malfunction.



- **Do not touch moving parts of the lens or other moving parts.** Failure to observe this precaution could result in injury.
- **Do not fire the flash in contact with or in close proximity to the skin or objects.** Failure to observe this precaution could result in burns or fire.
- **Do not raise the built-in flash when using a flash unit mounted on the camera accessory shoe.** Failure to observe this precaution could result in fire or product malfunction.
- **Do not leave the product where it will be exposed to extremely high temperatures, for an extended period such as in an enclosed automobile or in direct sunlight.** Failure to observe this precaution could result in fire or product malfunction.
- **Do not transport the camera with a tripod or similar accessory attached.** Failure to observe this precaution could result in injury or product malfunction.



## **DANGER for batteries**

- **Do not mishandle batteries.** Failure to observe the following precautions could result in the batteries leaking, overheating, rupturing, or catching fire:
  - Use only rechargeable batteries approved for use in this product.
  - Do not expose batteries to flame or excessive heat.
  - Do not disassemble.
  - Do not short-circuit the terminals by touching them to necklaces, hairpins, or other metal objects.
  - Do not expose batteries or the products in which they are inserted to powerful physical shocks.
  - Do not step on batteries, pierce them with nails, or strike them with hammers.
- **Charge only as indicated.** Failure to observe this precaution could result in the batteries leaking, overheating, rupturing, or catching fire.
- **If battery liquid comes into contact with the eyes, rinse with plenty of clean water and seek immediate medical attention.** Delaying action could result in eye injuries.









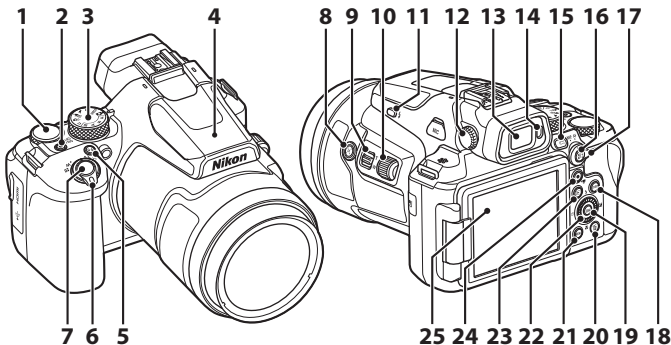

## WARNING for batteries

- **Keep batteries out of reach of children.** Should a child swallow a battery, seek immediate medical attention.
- **Keep batteries out of reach of household pets and other animals.** The batteries could leak, overheat, rupture, or catch fire if bitten, chewed, or otherwise damaged by animals.
- **Do not immerse batteries in water or expose to rain.** Failure to observe this precaution could result in fire or product malfunction. Immediately dry the product with a towel or similar object should it become wet.
- **Discontinue use immediately should you notice any changes in the batteries, such as discoloration or deformation. Cease charging EN-EL20a rechargeable batteries if they do not charge in the specified period of time.** Failure to observe these precautions could result in the batteries leaking, overheating, rupturing, or catching fire.
- **When batteries are no longer needed, insulate the terminals with tape.** Overheating, rupture, or fire may result should metal objects come into contact with the terminals.
- **If battery liquid comes into contact with a person's skin or clothing, immediately rinse the affected area with plenty of clean water.** Failure to observe this precaution could result in skin irritation.

# Parts of the camera

## The camera body



- |    |   |    |  |
|----|---|----|--|
| 1  | Command dial  | 14 | Eye sensor   |
| 2  | Power switch/power-on lamp (charge lamp)  | 15 |  (monitor) button         |
| 3  | Mode dial   | 16 |  (AE-L/AF-L) button       |
| 4  | Built-in flash  | 17 | Focus-mode selector  |
| 5  | <b>Fn</b> (function) button   | 18 | <b>DISP</b> (display) button   |
| 6  | Zoom control  | 19 |  (apply selection) button |
| 7  | Shutter-release button  | 20 |  (delete) button          |
| 8  |  (snap-back zoom) button | 21 | <b>MENU</b> (menu) button  |
| 9  | Side zoom control   | 22 | Rotary multi selector (multi selector)*  |
| 10 | Side dial   | 23 |  (playback) button      |
| 11 |  (flash pop-up) button   | 24 |  (movie-record) button  |
| 12 | Diopter adjustment control  | 25 | Monitor  |
| 13 | Electronic viewfinder   |    |  |

\* Pressing up, down, left, or right on the multi selector is expressed as ▲, ▼, ◀, or ▶.  
For information about parts other than those listed above and display details on the screen, see the "Online Manual" or "Reference Manual" for this product.

# Getting started

## Attaching the strap

Attach the strap to the left and right side of the camera.

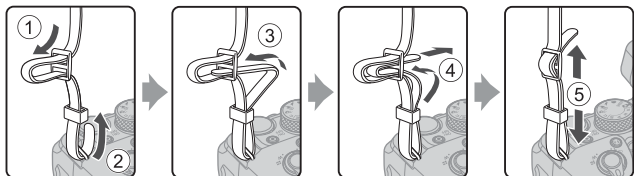

## Attaching/removing the lens cap and lens hood

- When you are not shooting images, attach the lens cap to protect the lens.
- When the lens hood is attached, it cuts out light which adversely affects the image, and also helps protect the camera. Remove the lens hood when shooting with a flash or when the AF-assist illuminator is necessary for shooting.
- Turn off the camera before attaching/removing the lens hood. When attaching the lens hood, screw it in sufficiently without excessive force so that it will not fall off.

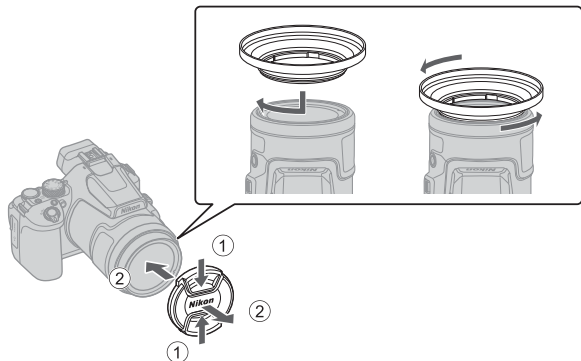

## Inserting the battery and memory card

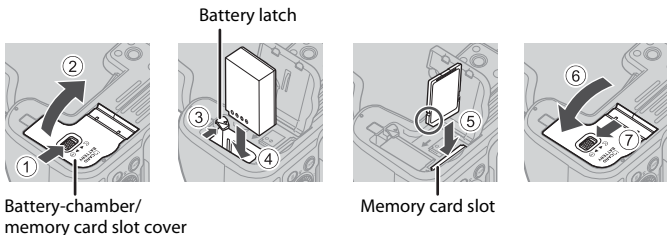

- With the battery's positive and negative terminals oriented correctly, move the orange battery latch (③), and fully insert the battery (④).
- Slide the memory card in until it clicks into place (⑤).
- Be careful not to insert the battery or memory card upside-down or backward, as this could cause a malfunction.
- If the write-protect switch of the memory card is locked, you cannot shoot, delete images, or format the memory card.
- See "Memory cards that can be used" (📖30) for information about compatible memory cards.

### ✓ Formatting a memory card

The first time you insert a memory card that has been used in another device into this camera, make sure to format it with this camera.

- **Note that formatting a memory card permanently deletes all images and other data on the memory card.** Be sure to make copies of any images you wish to keep before formatting the memory card.
- Insert the memory card into the camera, press the **MENU** button, and select the setup menu (📖18) → **[Format card]**.

### Removing the battery or memory card

Turn the camera off and make sure that the power-on lamp and screen have turned off, and then open the battery-chamber/memory card slot cover.

- Move the battery latch to eject the battery.
- Gently push the memory card into the camera to partially eject the memory card.
- Be careful when handling the camera, battery, and memory card immediately after using the camera, as they may be hot.

## Charging the battery

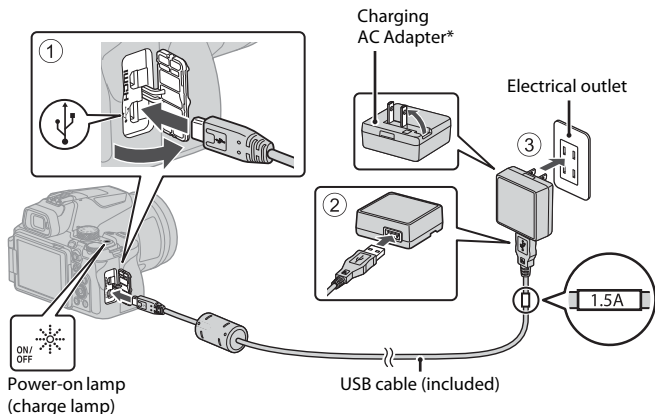

\* A plug adapter is attached depending on the country or region of purchase. The shape of the plug adapter varies with the country or region of purchase.

- Charging starts when the camera is connected to an electrical outlet while the battery is inserted, as shown in the illustration. The power-on lamp (charge lamp) flashes while the battery is charging.
- When charging is complete, the power-on lamp (charge lamp) turns off. Unplug the Charging AC Adapter from the electrical outlet, and disconnect the USB cable. Charging time is about 3 hours for a fully exhausted battery.
- The battery cannot be charged when the power-on lamp (charge lamp) quickly flashes, possibly due to one of the reasons described below.
  - The ambient temperature is not suited to charging.
  - The USB cable or Charging AC Adapter is not properly connected.
  - The battery is damaged.

### ✓ Notes about the USB cable

- Do not use a USB cable other than the UC-E21. Using a USB cable other than the UC-E21 could result in overheating, fire, or electric shock.
- Check the shape and direction of the plugs and do not insert or remove the plugs at an angle.

### ✓ Notes about charging the battery

- Do not, under any circumstances, use another make or model of AC adapter other than the EH-73P Charging AC Adapter, and do not use a commercially available USB-AC adapter or a battery charger for a mobile phone. Failure to observe this precaution could result in overheating or in damage to the camera.
- If the camera is turned on while the battery is charging, charging stops.

## Opening the monitor

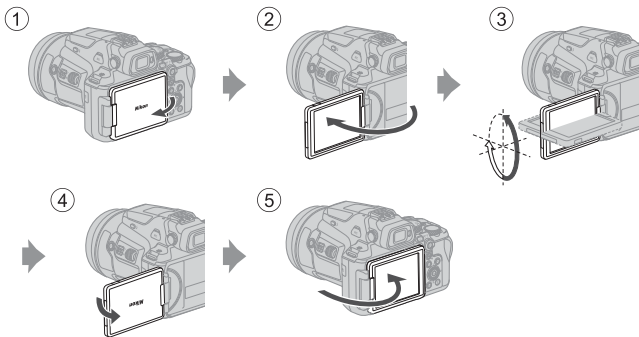

- You can adjust the direction and angle of the monitor. For normal shooting, fold the monitor against the back of the camera, facing out (⑤).
- When you are not using or carrying the camera, fold the monitor against the camera body with the screen facing in (①).

### ✓ Notes about the monitor

- The monitor's adjustable range may be limited when a cable or accessories are attached to the camera.
- When moving the monitor, do not apply excessive force and move slowly within the monitor's adjustable range so that the connection will not be damaged.

## Camera setup

When the camera is turned on for the first time, screens to set the display language and camera clock are displayed.

Use the multi selector and **OK** (apply selection) button to select and adjust settings.

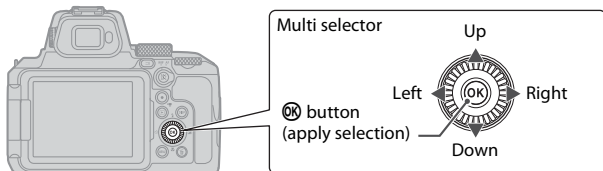

- 1 Press the power switch to turn on the camera.

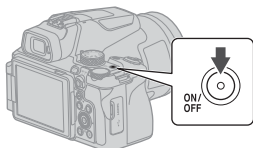

- 2 Press **▲▼** on the multi selector to highlight a language and press the **OK** button to select.

- The displayed languages vary depending on the country or region.

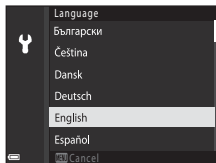

- 3 Select **[Yes]** and press the **OK** button.

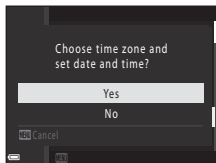



#### 4 Highlight your home time zone and press the **OK** button.

- To turn daylight saving time on, press ▲; ☀ will be displayed above the map. Press ▼ to turn daylight saving time off.

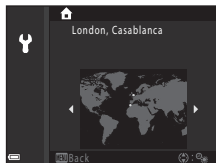

#### 5 Press ▲▼ to select a date format and press the **OK** button.

#### 6 Set the date and time.

- Press ◀▶ to highlight items and ▲▼ to change them.
- Select the minute field and press the **OK** button to confirm the setting.

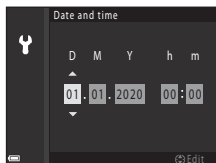

#### 7 When prompted, press ▲▼ to highlight **[Yes]** and press the **OK** button.

- Setup is complete and the camera switches to the shooting screen.

#### **Setting the language**

The language can be set at any time in the  setup menu (📖18) → **[Language]**.

#### **To change the time zone and date setting**

Set in the  setup menu (📖18) → **[Time zone and date]**.

In **[Time zone and date]** → **[Time zone]**, the time is one hour earlier when daylight saving time is on, and goes back one hour when it is off.

# Basic operations of shooting and playback



## Shooting still images

 (auto) mode is used here as an example.  (auto) mode enables you to perform general shooting in a variety of shooting conditions.

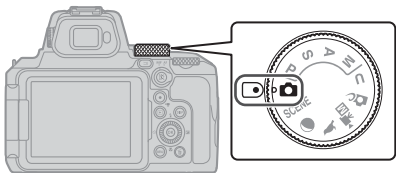
- 1 Rotate the mode dial to .



- 2 Check the battery level and number of exposures remaining on the shooting screen.

- Battery level
  - : The battery level is high.
  - : The battery level is low.
- Press the **DISP** (display) button to switch the information displayed on the screen each time.

Number of exposures remaining

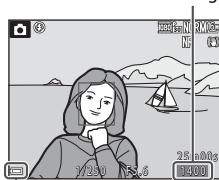

Battery level

- 3 Hold the camera steady.

- Keep fingers and other objects away from the lens, flash, AF-assist illuminator, eye sensor, microphone, and speaker.

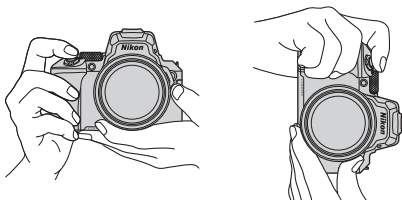

## 4 Frame the picture.

- Move the zoom control or the side zoom control to change the zoom lens position.
- If you lose sight of the subject while shooting with the lens in telephoto position, press the  (snap-back zoom) button to temporarily widen the visible area so that you can frame the subject more easily.

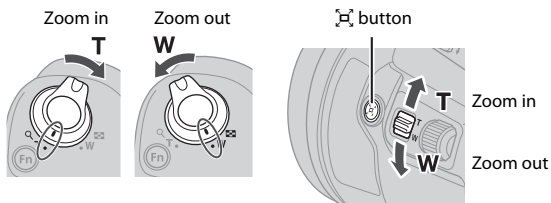

### Using a tripod

- We recommend using a tripod to stabilize the camera in the following situations:
  - When shooting in dim lighting and the flash is  (off)
  - When the zoom is at a telephoto position
- When using a tripod to stabilize the camera during shooting, select the setup menu (18) → **[Vibration reduction]** → **[Off]** to prevent potential errors caused by this function.
- After attaching the camera to a tripod, make sure that the camera does not fall over when zooming the lens in or out. Extend one leg of the tripod toward the subject and the other two legs toward you at an equal distance.

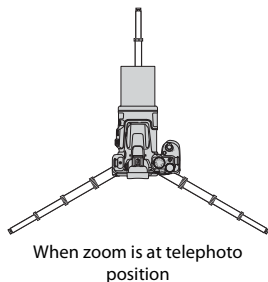
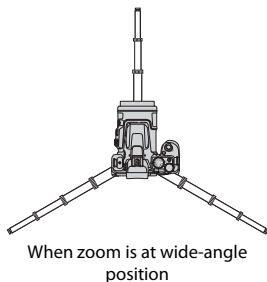

- The camera may move slightly when operated, even if it is attached to a tripod, which may interfere with the autofocus. Wait a few seconds after operating the camera, and then slowly press the shutter-release button.

## 5 Press the shutter-release button halfway.

- To press the shutter-release button “halfway” means to press and hold the button at the point where you feel a slight resistance.
- When the subject is in focus, the focus area or focus indicator is displayed in green.
- When you are using digital zoom, the camera focuses in the center of the frame and the focus area is not displayed.
- If the focus area or focus indicator flashes, the camera is unable to focus. Modify the composition and try pressing the shutter-release button halfway again.

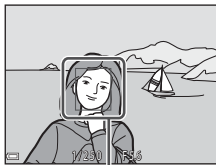
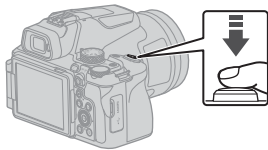

Focus area

## 6 Without lifting your finger, press the shutter-release button all the way down.



### Notes about saving images or movies

The indicator showing the number of exposures remaining or the indicator showing the remaining recording time flashes, or **[Please wait for the camera to finish recording.]** is displayed while images or movies are being saved. **Do not open the battery-chamber/memory card slot cover or remove the battery or memory card** while an indicator is flashing. Doing this could result in loss of data, or in damage to the camera or the memory card.

### The auto off function

- When no operations are performed for about one minute, the screen turns off, the camera enters standby mode, and then the power-on lamp flashes. The camera turns off after remaining in standby mode for about three minutes.
- To turn the screen back on while the camera is in standby mode, perform an operation such as pressing the power switch or shutter-release button.

## Using the built-in flash

In situations where a flash is needed, such as in dark locations or when the subject is backlit, press the ⚡ (flash pop-up) button to raise the built-in flash.

- When not using the built-in flash, gently push to lower the built-in flash until it clicks shut.

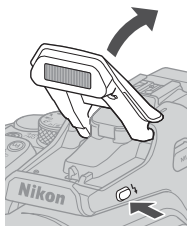

## How to attach the BS-1 Accessory Shoe Cover (available separately)

①

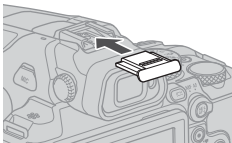

②

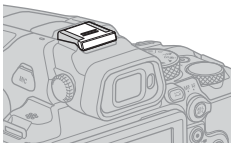

## Recording movies

Display the shooting screen and press the ● (▶🎥 movie-record) button to start recording a movie. Press the ● (▶🎥) button again to end recording.

- When you rotate the mode dial to 🎥 (Movie manual), you can set the shutter speed and f-number for movie recording.

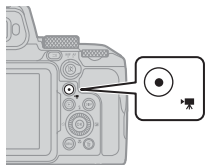

## Switching between the monitor and viewfinder

It is recommended that you use the viewfinder when bright conditions make it difficult to see the monitor, such as when outdoors in sunlight.

- When you bring your face close to the viewfinder, the eye sensor responds to it and the viewfinder turns on, and the monitor turns off (default setting).
- You can also press the  (monitor) button to switch the display between the monitor and viewfinder.

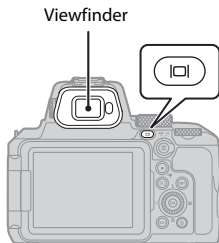

### Diopter adjustment of the viewfinder

When the display in the viewfinder is difficult to see, adjust by rotating the diopter adjustment control while looking through the viewfinder.

- Take care not to scratch your eye with your fingertips or nails.

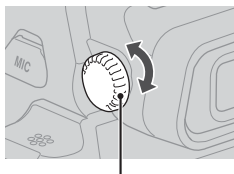

Diopter adjustment control



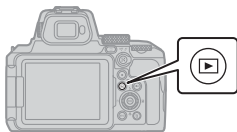

# Playing back images

**1** Press the  (playback) button to enter full-frame playback mode.

- If you press and hold down the  button while the camera is turned off, the camera turns on in playback mode.



**2** Use the multi selector to select an image to display.

- Press and hold down  to scroll through the images quickly.
- Images can also be selected by rotating the multi selector.
- Press the **DISP** (display) button to switch the information displayed on the screen each time.
- To play back a recorded movie, press the  button.
- To return to shooting mode, press the  button or shutter-release button.
- Move the zoom control toward **T** () in full-frame playback mode to zoom in on an image.

Display the previous image

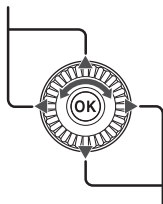

Display the next image







- In full-frame playback mode, move the zoom control toward **W** () to switch to thumbnail playback mode and display multiple images on the screen.

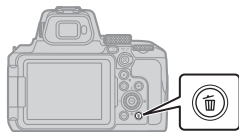

## Deleting images



- 1 In playback mode, press the  (delete) button to delete the image currently displayed on the screen.



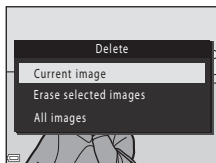

- 2 Use the multi selector   to select the desired deletion method and press the  button.

- If you selected [**Current image**] or [**All images**], proceed to step 6.
- To exit without deleting, press the **MENU** button.



- 3 Use the multi selector   or rotate it to select the image that you want to delete.

- Move the zoom control toward **T** () to switch to full-frame playback, or **W** () to switch to thumbnail playback.

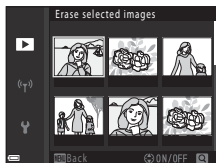

- 4 Use   to show or hide .

- Show  under images that you want to delete. Repeat steps 3 and 4 to select additional images.

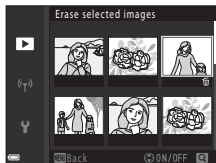

- 5 Press the  button to apply the image selection.



## 6 When the confirmation dialog is displayed, select **[Yes]** and press the **OK** button.

- Deleted images cannot be recovered.
- The message in the confirmation dialog varies depending on the selected deletion method.

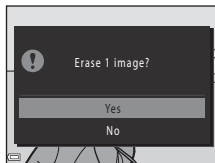

### **✓** Notes about deleting images simultaneously saved in RAW and JPEG

When using this camera to delete images captured using **[RAW + Fine]** or **[RAW + Normal]** in the **[Image quality]** setting, both of the simultaneously saved RAW and JPEG images are deleted. You cannot delete only one format.

### **✓** Deleting images captured continuously (sequence)

- Images captured continuously are saved as a sequence, and only the first image of the sequence (the key picture) is displayed in playback mode (default setting).
- If you press the **🗑** button while a key picture is displayed for a sequence of images, all images in the sequence are deleted.
- To delete individual images in a sequence, press the **OK** button to display them one at a time and press the **🗑** button.



### **📎** Deleting the image captured while in shooting mode

When using shooting mode, press the **🗑** button to delete the last image that was saved.

# Other functions

## Selecting a shooting mode (mode dial)

You can rotate the mode dial to align the desired shooting mode with the indicator mark on the camera body.

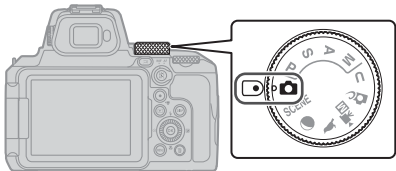

- **📷 (Auto) mode**  
Select this mode to perform general shooting in a variety of shooting conditions.
- **P, S, A, and M modes**  
Select these modes for greater control over shutter speed and f-number.
- **U (User settings) mode**  
The frequently used settings in **P**, **S**, **A**, and **M** modes can be saved. To shoot with the saved settings, rotate the mode dial to **U**.
- **🎨 (Creative) mode**  
Apply effects to images during shooting.
- **🎥 (Movie manual) mode**  
You can record movies with the exposure mode set to aperture-priority auto or manual.  
Still images cannot be captured.
- **🦅, 🌕, and SCENE modes**  
Select any one of scene modes based on the shooting conditions, and you can take pictures with the appropriate settings for those conditions.
  - 🦅 (bird-watching): Use this mode when capturing images of birds in a telephoto position.
  - 🌕 (moon): Use this mode when capturing images of the moon in a telephoto position.
  - **SCENE** (scene): Press the **MENU** button and select a scene mode.

## Setting the flash mode, self-timer, focus mode, and exposure compensation

When the shooting screen is displayed, you can press the multi selector ▲ (⚡) ► (☒) ▼ (🌸) ◀ (🕒) to set the functions described below.

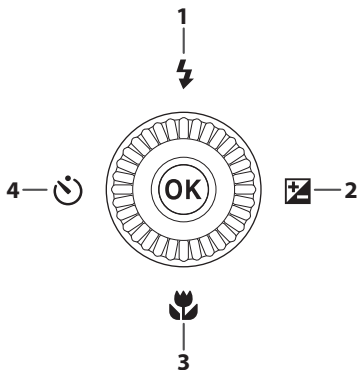

1	<b>Flash mode</b> The flash mode can be set according to shooting conditions.
2	<b>Exposure compensation</b> You can adjust overall image brightness.
3	<b>Focus mode</b> When the focus-mode selector is set to <b>AF</b> (autofocus), you can specify the focus mode according to the distance to the subject.
4	<b>Self-timer/Smile timer</b> The camera releases the shutter when the specified time elapses after you press the shutter-release button. If ☒ [Smile timer] is set, the camera automatically releases the shutter whenever a smiling face is detected.

The functions that can be set vary depending on the shooting mode.

# Menu operations

You can press the **MENU** (menu) button to display the menu screen and change the camera's settings.

- The displayed menu varies depending on the status of the camera (during shooting or playback).
- Menu items are categorized by the icons on the left side of the screen.

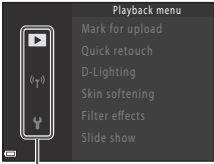
When shooting	During playback
 <p>Shooting menu</p> <ul style="list-style-type: none"><li>Image quality</li><li>Image size</li><li>Picture Control</li><li>Custom Picture Control</li><li>White balance</li><li>Metering</li></ul>	 <p>Playback menu</p> <ul style="list-style-type: none"><li>Mark for upload</li><li>Quick retouch</li><li>D-Lighting</li><li>Skin softening</li><li>Filter effects</li><li>Slide show</li></ul>
<p>Menu categories</p> <ul style="list-style-type: none"><li>• <b>P Shooting menu</b><sup>1,3</sup></li><li>• <b>Movie manual mode menu</b><sup>2</sup></li><li>• <b>Movie menu</b><sup>3</sup></li><li>• <b>Network menu</b></li><li>• <b>Setup menu</b></li></ul>	<p>Menu categories</p> <ul style="list-style-type: none"><li>• <b>Playback menu</b></li><li>• <b>Network menu</b></li><li>• <b>Setup menu</b></li></ul>

<sup>1</sup> Menu names and icons vary depending on the shooting mode.

<sup>2</sup> Displayed when the mode dial is rotated to **Movie manual mode menu**.

<sup>3</sup> Displayed when the mode dial is rotated to a mode other than **Movie manual mode menu**.

- 1** Press the **MENU** (menu) button to display the menu screen.

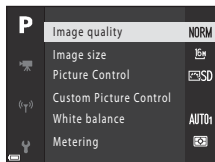
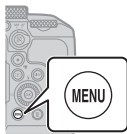

- 2** Press the multi selector ◀ to move to the menu category selection area.

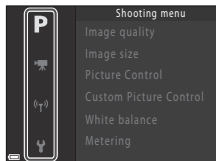

- 3** Press ▲▼ or rotate the multi selector to change menu categories.

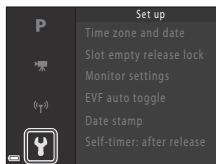

- 4** Press the **OK** button to confirm the menu category.

- Menu items corresponding to the selected menu category are displayed.

- 5** Press ▲▼ or rotate the multi selector to select a menu option, and press the **OK** button to confirm the selection.

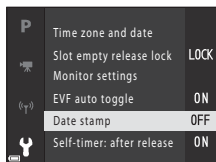

- Certain options cannot be selected depending on the current shooting mode or the state of the camera.

- 6** Press ▲▼ or rotate the multi selector to select a setting, and press the **OK** button to confirm the selection.

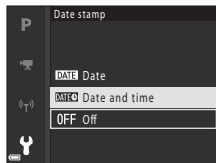

- When you are finished using the menu, press the **MENU** button.
- When a menu is displayed, you can return to shooting mode by pressing the shutter-release button or **MOVIE** (movie-record) button.

## To change the flash mode, self-timer, focus mode, and exposure compensation settings

You can press the multi selector ▲ (flash mode), ◀ (self-timer), ▼ (focus mode), or ▶ (exposure compensation) to configure them on the shooting screen (📖17).

## Using the Fn (function) button

If you press the Fn button in **P**, **S**, **A**, **M**, or **U** mode, you can quickly configure the pre-saved menu options (default setting is **[Continuous]**). To set a different menu option, select  **[Fn button]** and select the desired menu option.

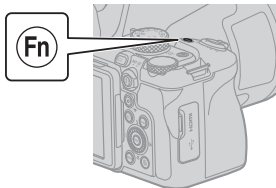

## Connect to a smart device

### Installing the SnapBridge app

When you wirelessly connect the camera and a smart device with the SnapBridge app installed, you can send pictures and movies taken with the camera to the smart device. You can also use the smart device to control the camera remotely and shoot.



- Download the app from the Apple App Store® for iOS, and from Google Play™ for Android™. **The “SnapBridge 360/170 app” cannot be used with this camera.**



- Visit the applicable download site for more information about supported OS versions.
- For details about how to use your smart device, refer to the documentation provided with the smart device.

## Connecting the camera and a smart device

- Insert a memory card with sufficient free space into the camera.
- Make sure that the remaining battery levels of the camera and smart device are sufficient.
- Enable Bluetooth and the location data functions on the smart device.

- 1** Press the **MENU** button, select the [**Network menu**] → [**Connect to smart device**], and press the **OK** button.

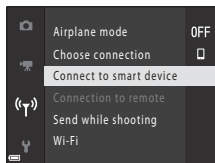
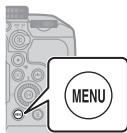

- 2** When the dialog at the right is displayed, start the SnapBridge app.

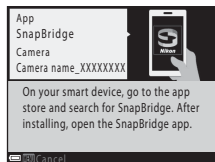

- Follow the instructions displayed in the camera and the SnapBridge app.
- For details about using the SnapBridge app, see the "SnapBridge Online Help" (<https://nikonimglib.com/snbr/onlinehelp/en/index.html>).

# If there is a problem

## Troubleshooting

If the camera fails to function as expected, check the following before consulting your retailer or Nikon-authorized service representative.

- Turning off the camera once may solve the issue.
- If you cannot find a relevant entry, also check “If there is a problem” in the detailed “Online Manual” or “Reference Manual” (📖ii) or the Nikon website for your region.

Problem	Cause/Solution	📖
The camera is on but does not respond.	<ul style="list-style-type: none"><li>• Wait for recording to end.</li><li>• If the problem persists, turn the camera off.</li></ul> If the camera does not turn off, remove and reinsert the battery or batteries or, if you are using an AC adapter, disconnect and reconnect the AC adapter. Note that although any data currently being recorded will be lost, data that have already been recorded will not be affected by removing or disconnecting the power source.	–
The camera cannot be turned on.	The battery is exhausted.	3, 4, 27
The camera turns off without warning.	<ul style="list-style-type: none"><li>• The camera automatically turns off to save power (auto off function).</li><li>• The camera and battery may not work properly at low temperatures.</li><li>• The inside of the camera has become hot. Leave the camera off until the inside of the camera has cooled, and then try turning it on again.</li></ul>	10 27 –
The monitor or viewfinder is blank.	<ul style="list-style-type: none"><li>• The camera automatically turns off to save power (auto off function).</li><li>• You cannot turn on both the monitor and viewfinder at the same time. It may take a while to switch between the monitor and viewfinder.</li><li>• The camera is connected to a TV or computer.</li><li>• The screen may turn off during shooting intervals or when capturing images with a long time-exposure.</li></ul>	10 – – –
The camera becomes hot.	The camera may become hot when used for an extended period of time such as to shoot movies, or when used in a hot environment; this is not a malfunction.	–



# Technical notes

## Notices

### Notices for customers in Europe

**CAUTION: RISK OF EXPLOSION IF BATTERY IS REPLACED BY AN INCORRECT TYPE.**

This symbol indicates that electrical and electronic equipment is to be collected separately.

The following apply only to users in European countries:

- This product is designated for separate collection at an appropriate collection point. Do not dispose of as household waste.
- Separate collection and recycling helps conserve natural resources and prevent negative consequences for human health and the environment that might result from incorrect disposal.
- For more information, contact the retailer or the local authorities in charge of waste management.



### **DISPOSE OF USED BATTERIES ACCORDING TO THE INSTRUCTIONS.**

This symbol on the battery indicates that the battery is to be collected separately.

The following apply only to users in European countries:

- All batteries, whether marked with this symbol or not, are designated for separate collection at an appropriate collection point. Do not dispose of as household waste.
- For more information, contact the retailer or the local authorities in charge of waste management.



## Notes about wireless communication functions

### Restrictions on wireless devices

The wireless transceiver included in this product conforms to wireless regulations in the country of sale and is not for use in other countries (products purchased in the EU or EFTA can be used anywhere within the EU and EFTA). Nikon does not accept liability for use in other countries. Users who are unsure as to the original country of sale should consult with their local Nikon service center or Nikon-authorized service representative. This restriction applies to wireless operation only and not to any other use of the product.

## **Security**

Although one of the benefits of this product is that it allows others to freely connect for the wireless exchange of data anywhere within its range, the following may occur if security is not enabled:

- Data theft: Malicious third-parties may intercept wireless transmissions to steal user IDs, passwords, and other personal information.
- Unauthorized access: Unauthorized users may gain access to the network and alter data or perform other malicious actions. Note that due to the design of wireless networks, specialized attacks may allow unauthorized access even when security is enabled. Nikon is not responsible for data or information leaks that may occur during data transfer.
- Do not access networks that you are not permitted to use, even if they are displayed on your smartphone or tablet. Doing so may be regarded as unauthorized access. Only access networks that you are permitted to use.

## **Personal information management and disclaimer**

- User information registered and configured on the product, including wireless LAN connection settings and other personal information, is susceptible to alteration and loss resulting from operational error, static electricity, accident, malfunction, repair or other handling. Always keep separate copies of important information. Nikon is not responsible for any direct or indirect damages or lost profits resulting from alteration or loss of content that is not attributable to Nikon.
- Before discarding this product or transferring it to another owner, select the setup menu (📖18) → **[Reset all]** to delete all user information registered and configured with the product, including wireless LAN connection settings and other personal information.
- Nikon is not responsible for any damages resulting from unauthorized use of this product by third parties in the event that the product is stolen or lost.

## **Precautions when exporting or carrying this product abroad**

This product is controlled by the United States Export Administration Regulations (EAR). The permission of the United States government is not required for export to countries other than the following, which as of this writing are subject to embargo or special controls: Cuba, Iran, North Korea, Sudan, and Syria (list subject to change).

## **Notice for customers in Europe**

### **Declaration of Conformity (Europe)**

Hereby, Nikon Corporation declares that the radio equipment type COOLPIX P950 is in compliance with Directive 2014/53/EU.

The full text of the EU declaration of conformity is available at the following internet address: [https://imaging.nikon.com/support/pdf/DoC\\_N1834.pdf](https://imaging.nikon.com/support/pdf/DoC_N1834.pdf).

- Maximum output power:
  - Wi-Fi: 9.2 dBm (EIRP)
  - Bluetooth: 7.2 dBm (EIRP)
  - Bluetooth Low Energy: 7.2 dBm (EIRP)
- Operating frequency:
  - Wi-Fi: 2412–2462 MHz (1–11 channels)
  - Bluetooth: 2402–2480 MHz
  - Bluetooth Low Energy: 2402–2480 MHz

## **Caring for the product**

Observe the precautions described below in addition to the warnings in “For your safety” (📖vii-x) when using or storing the device.

### **The camera**

#### **Do not apply strong impact to the camera**

The product may malfunction if subjected to strong shock or vibration. In addition, do not touch or apply force to the lens.

#### **Keep dry**

The device will be damaged if immersed in water or subjected to high humidity.

#### **Do not disassemble**

Do not, under any circumstances, disassemble the camera because it is composed of many precise circuits.

#### **Avoid sudden changes in temperature**

Sudden changes in temperature, such as when entering or leaving a heated building on a cold day, can cause condensation to form inside the device. To prevent condensation, place the device in a carrying case or a plastic bag before exposing it to sudden changes in temperature.

#### **Keep away from strong magnetic fields**

Do not use or store this device in the vicinity of equipment that generates strong electromagnetic radiation or magnetic fields. Doing so could result in loss of data or camera malfunction.

## Do not point the lens at the sun

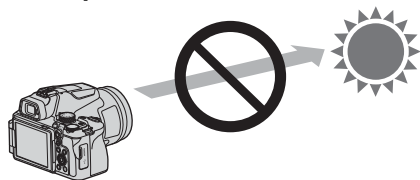

Avoid pointing the lens at the sun or other strong light sources when shooting or when leaving the camera unattended without a lens cap. Strong light sources such as sunlight are concentrated through the lens, which may cause deformation of the internal parts of the lens or discoloration or burn-in on the image sensor. The camera may be damaged even when the lens is pointed toward the sun for a few seconds, particularly when the lens is in a telephoto position. The camera may not be able to perform exposure control when the internal parts of the lens are deformed.

Unevenness may appear in images when discoloration or burn-in occurs on the image sensor. It is recommended that you attach the lens cap when you are not using the camera.

## Lasers and other bright light sources

Do not direct lasers or other extremely bright light sources toward the lens, as this could damage the camera's image sensor.

## Turn the product off before removing or disconnecting the power source or memory card

Do not remove the battery while the product is on, or while images are being saved or deleted. Forcibly cutting power in these circumstances could result in loss of data or in damage to the memory card or internal circuitry.

## Notes about the monitor

- Monitors (including electronic viewfinders) are constructed with extremely high precision; at least 99.99% of pixels are effective, with no more than 0.01% being missing or defective. Hence while these displays may contain pixels that are always lit (white, red, blue, or green) or always off (black), this is not a malfunction and has no effect on images recorded with the device.
- Images in the monitor may be difficult to see under bright lighting.
- Do not apply pressure to the monitor, as this could cause damage or malfunction. Should the monitor break, care should be taken to avoid injury caused by broken glass and to prevent the liquid crystal from the display touching the skin or entering the eyes or mouth.

# The battery

## Precautions for use

- Note that the battery may become hot after use.
- Do not use the battery at ambient temperatures below 0°C (32°F) or above 40°C (104°F) as this could cause damage or malfunction.
- If you notice any abnormalities such as excessive heat, smoke, or an unusual smell coming from the battery, immediately discontinue use and consult your retailer or Nikon-authorized service representative.
- After removing the battery from the camera or optional battery charger, put the battery in a plastic bag, etc. in order to insulate it.

## Charging the battery

Check the battery level before using the camera and replace or charge the battery if necessary.

- Charge the battery indoors with an ambient temperature of 5°C to 35°C (41°F to 95°F) before use.
- A high battery temperature may prevent the battery from charging properly or completely, and may reduce battery performance. Note that the battery may become hot after use; wait for the battery to cool before charging. When charging the battery inserted into this camera using the Charging AC Adapter or a computer, the battery is not charged at battery temperatures below 0°C (32°F) or above 50°C (122°F).
- Do not continue charging once the battery is fully charged as this will result in reduced battery performance.
- The battery temperature may increase during charging. However, this is not a malfunction.

## Carrying spare batteries

Whenever possible, carry fully charged spare batteries when taking pictures on important occasions.

## Using the battery when cold

On cold days, the capacity of batteries tends to decrease. If an exhausted battery is used at a low temperature, the camera may not turn on. Keep spare batteries in a warm place and exchange as necessary. Once warmed, a cold battery may recover some of its charge.

## Battery terminals

Dirt on the battery terminals may prevent the camera from functioning. Should the battery terminals become dirty, wipe them off with a clean, dry cloth before use.

## Charging an exhausted battery

Turning the camera on or off while an exhausted battery is inserted in the camera may result in reduced battery life. Charge the exhausted battery before use.

## Storing the battery

- Always remove the battery from the camera or optional battery charger when it is not being used. Minute amounts of current are drawn from the battery while it is in the camera, even when not in use. This may result in excessive battery drain and complete loss of function.
- Charging a used battery within six months is recommended. When storing the battery for long periods, recharge it at least once every six months and use the camera until the battery level indicator is  before returning it to storage.
- Put the battery in a plastic bag, etc. in order to insulate it and store it in a cool place. The battery should be stored in a dry location with an ambient temperature of 15°C to 25°C (59°F to 77°F). Do not store the battery in hot or extremely cold locations.

## Battery life

A marked drop in the time a fully charged battery retains its charge, when used at room temperature, indicates that the battery needs to be replaced. Purchase a new battery.

## Recycling used batteries

Recycle rechargeable batteries in accord with local regulations, being sure to first insulate the terminals with tape.

## The Charging AC Adapter

- The EH-73P Charging AC Adapter is for use only with compatible devices. Do not use with another make or model of device.
- Do not use any USB cable other than the UC-E21. Using a USB cable other than the UC-E21 could result in overheating, fire or electric shock.
- Do not, under any circumstances, use another make or model of AC adapter other than the EH-73P Charging AC Adapter, and do not use a commercially available USB-AC adapter or a battery charger for a mobile phone. Failure to observe this precaution could result in overheating or in damage to the camera.
- The EH-73P is compatible with AC 100–240 V, 50/60 Hz electrical outlets. When using in other countries, use a plug adapter (commercially available) as necessary. For more information about plug adapters, consult your travel agency.
- The symbols on this product represent the following:
  - ~ AC, --- DC,  Class II equipment (The construction of the product is double-insulated.)

## Cleaning and storage

### Cleaning

Do not use alcohol, thinner, or other volatile chemicals.

Lens/ viewfinder	Avoid touching glass parts with your fingers. Remove dust or lint with a blower (typically a small device with a rubber bulb attached to one end that is pumped to produce a stream of air out the other end). To remove fingerprints or other stains that cannot be removed with a blower, wipe the lens with a soft cloth, using a spiral motion that starts at the center of the lens and working toward the edges. If this fails, clean the lens using a cloth lightly dampened with commercial lens cleaner.
Monitor	Remove dust or lint with a blower. To remove fingerprints and other stains, clean the monitor with a soft, dry cloth, being careful not to apply pressure.
Body	Use a blower to remove dust, dirt, or sand, then wipe gently with a soft, dry cloth. After using the camera at the beach or other sandy or dusty environment, wipe off any sand, dust, or salt with a dry cloth lightly dampened with fresh water and dry thoroughly. <b>Note that foreign matter inside the camera could cause damage not covered by the warranty.</b>

### Storage

Remove the battery if the camera will not be used for an extended period. To prevent mold or mildew, take the camera out of storage at least once a month.

Turn the camera on and release the shutter a few times before putting the camera away again. Do not store the camera in any of the following locations:

- Places that are poorly ventilated or subject to humidity of over 60%
- Places exposed to temperatures above 50°C (122°F) or below -10°C (14°F)
- Places next to equipment that produces strong electromagnetic fields, such as televisions or radios

For storing the battery, follow the precautions in “The battery” (📖27) in “Caring for the product” (📖25).

## Memory cards that can be used

The camera supports SD, SDHC, and SDXC memory cards.

- The camera supports UHS-I.
  - Memory cards with an SD Speed Class rating of 6 (Video Speed Class V6) or faster are recommended for recording movies. When **[Movie options]** is set to **[2160/30p]** (4K UHD) or **[2160/25p]** (4K UHD), memory cards with a UHS Speed Class rating of 3 (Video Speed Class V30) or faster are recommended. Movie recording may stop unexpectedly when a memory card with a lower Speed Class rating is used.
  - If you use a card reader, make sure that it is compatible with your memory card.
  - Contact the manufacturer for information on features, operation, and limitations on use.
- 

## Trademark information

- Windows is either a registered trademark or trademark of Microsoft Corporation in the United States and/or other countries.
- The *Bluetooth*® word mark and logos are registered trademarks owned by Bluetooth SIG, Inc. and any use of such marks by Nikon Corporation is under license.
- Apple®, App Store®, the Apple logos, Mac, OS X, macOS, iPhone®, iPad®, iPod touch® and iBooks are trademarks or registered trademarks of Apple Inc., in the U.S. and other countries.
- Android, Google Play and the Google Play logo are trademarks of Google LLC. The Android robot is reproduced or modified from work created and shared by Google and used according to terms described in the Creative Commons 3.0 Attribution License.
- iOS is a trademark or registered trademark of Cisco Systems, Inc., in the United States and/or other countries and is used under license.
- Adobe, the Adobe logo, Acrobat, and Reader are either trademarks or registered trademarks of Adobe Systems Incorporated in the United States and/or other countries.
- SDXC, SDHC, and SD Logos are trademarks of SD-3C, LLC.



- HDMI, HDMI logo and High-Definition Multimedia Interface are trademarks or registered trademarks of HDMI Licensing, LLC.

## HDMI



- Wi-Fi and the Wi-Fi logo are trademarks or registered trademarks of the Wi-Fi Alliance.
- All other trade names mentioned in this manual or the other documentation provided with your Nikon product are the trademarks or registered trademarks of their respective holders.

Use of the Made for Apple badge means that an accessory has been designed to connect specifically to the Apple products identified in the badge, and has been certified by the developer to meet Apple performance standards. Apple is not responsible for the operation of this device or its compliance with safety and regulatory standards. Please note that the use of this accessory with an Apple product may affect wireless performance.

## **AVC Patent Portfolio License**

This product is licensed under the AVC Patent Portfolio License for the personal and non-commercial use of a consumer to (i) encode video in compliance with the AVC standard ("AVC video") and/or (ii) decode AVC video that was encoded by a consumer engaged in a personal and non-commercial activity and/or was obtained from a video provider licensed to provide AVC video. No license is granted or shall be implied for any other use. Additional information may be obtained from MPEG LA, L.L.C. See <https://www.mpegla.com>.

## **FreeType License (FreeType2)**

Portions of this software are copyright © 2012 The FreeType Project (<https://www.freetype.org>). All rights reserved.

## **MIT License (HarfBuzz)**

Portions of this software are copyright © 2020 The HarfBuzz Project (<https://www.freedesktop.org/wiki/Software/HarfBuzz>). All rights reserved.

## Warranty Terms - Nikon Europe Service Warranty

Dear Nikon Customer,

We thank you for your purchasing this Nikon product. Should your Nikon product require warranty service, please contact the dealer from whom it was purchased or a member of our authorized service network within the sales territory of Nikon Europe B.V. (e.g. Europe/Russia/others). See details under:

<https://www.europe-nikon.com/support>

In order to avoid any unnecessary inconvenience, we advise you to read the user manuals carefully before contacting the dealer or our authorized service network.

Your Nikon equipment is guaranteed against any manufacturing defects for one full year from the date of original purchase. If during this period of guarantee the product proves defective due to improper material or workmanship, our authorized service network within the sales territory of Nikon Europe B.V. will, without charge for labor and parts, repair the product in the terms and conditions set as below. Nikon reserves the right (at its sole discretion) to replace or repair the product.

- 1.** This warranty is only provided upon presentation of the completed warranty card and original invoice or purchase receipt indicating the date of purchase, product type and dealer's name, together with the product. Nikon reserves the right to refuse free-of-charge warranty service if the above documents cannot be presented or if the information contained in it is incomplete or illegible.
- 2.** This warranty will not cover:
  - necessary maintenance and repair or replacement of parts due to normal wear and tear.
  - modifications to upgrade the product from its normal purpose as described in user manuals, without the prior written consent of Nikon.
  - transport costs and all risks of transport relating directly or indirectly to the warranty of the products.

- any damage resulting from modifications or adjustments which may be made to the product, without the prior written consent of Nikon, in order to comply with local or national technical standards in force in any other country than the ones for which the product was originally designed and/or manufactured.

**3.** The warranty will not be applicable in the case of:

- damage caused by misuse including but not limited to failure to use the product for its normal purpose or according to the user instructions on the proper use and maintenance, and to installation or use of the product inconsistent with the safety standards in force in the country where it is used.
- damage caused by accidents including but not limited to lightning, water, fire, misuse or neglect.
- defacing, illegibility or removal of the model or serial number on the product.
- damage resulting from repairs or adjustments which have been conducted by unauthorized service organizations or persons.
- defects in any system into which the product is incorporated or with which it is used.

**4.** This service warranty does not affect the consumer's statutory rights under applicable national laws in force, nor the consumer's right against the dealer arising from their sales/purchase contract.

**Notice:** An overview of all authorized Nikon Service Stations can be found online by following this Link (<https://www.europe-nikon.com/service/>).

No reproduction in any form of this manual, in whole or in part (except for brief quotation in critical articles or reviews), may be made without written authorization from NIKON CORPORATION.

**NIKON CORPORATION**

---

© 2020 Nikon Corporation



CT9L01(11)  
6MQ05311-01